

User Manual

Electric Torque Wrench MED



1. Introduction

Electric torque drivers of the MED series represent high quality tools designed for tightening, detaching and inspection of bolted connections. Users should carefully read this manual before starting to work. As this document has to be considered as an integral part of the equipment, it should remain available in its surroundings until the end of its lifetime. In case of any supplementary questions, do not hesitate and consult our factory service.

Patent right and copyright must be respected. Distribution, reproduction and transmission to third parties are not admissible.

2. Table of Contents

1.	Introduction	2
2.	Table of Contents	2
3.	Manufacturer	4
4.	EU Declaration of Conformity	4
5.	Safety Notes	5
5.1.	General Remarks	5
5.2.	Surroundings	5
5.3.	Electrical Safety	5
5.4.	Safety of Personnel	5
5.5.	Absence of Damages	5
6.	Content	5
7.	Product Identification	6
8.	Specification	6
9.	Detailed Description	6
9.1.	Start-up	6
9.2.	Initial Steps	6
9.3.	Switching ON	7
9.4.	Main Screen	7
9.5.	General Procedure	7
9.6.	Setting the Torque	7
9.7.	Units	7
9.8.	Adjustment of Follow-up Rotary Angle	8
9.9.	Preselections	8
9.10.	Advanced Menu	9
9.11.	Limits	9
9.12.	Bolt Counter	10
9.13.	Adjustment Lock	10
9.14.	Point Calibration	10
9.15.	Languages	11
9.16.	Prove Program	11
9.17.	Bolt Documentation System	11
9.18.	Set Date and Time	12
9.19.	Identification of a Operator	12
9.20.	Total and Maintenance Counter	13
9.21.	Device Information	13
9.22.	Diagnosis	13
9.23.	Key Lock	13
10.	Support for Reaction Arm	14
11.	PC-Software MED-Datalogger	15
11.1.	Add the electric torque driver as Bluetooth-Device under Windows	15
11.2.	Software Installation in Windows	15
11.3.	Software Set-up	15
11.4.	Read-out of Data	15
11.5.	Saving and Print of Data	15
11.6.	Synchronization of the Clock	15
12.	Trouble-Shooting	16
12.1.	Message "Voltage Fault"	16
12.2.	Message "Sensor Fault"	16
12.3.	Message "Insert SD Card"	16

12.4.	Instead of letters, the display shows merely lines _____	16
12.5.	Incorrect Date and Time _____	16
12.6.	Adjustment of Minimum or Maximum Torque Impossible _____	16
12.7.	No Reaction to Key Commands _____	16
12.8.	No Reaction to Start Button _____	16
12.9.	In left-handed rotation, bolts are not detached _____	16
12.10.	Error Message after Completion of Bolting _____	16
13.	Accessories _____	17
13.1.	Tool Suspension _____	17
13.2.	Extension Pieces _____	17
13.3.	Sockets and Securing Pins _____	17
14.	Disclaimer _____	17
15.	Maintenance / Service _____	17
15.1.	General Remarks _____	17
15.2.	Visual Inspection _____	17
15.3.	Service Intervals _____	17
15.4.	Spare Equipment _____	18
15.5.	Calibration _____	18
15.6.	Manufacturer's Address _____	18
16.	Product Overview _____	19

3. Manufacturer



M-PT Matjeschk-PowerTools GmbH & Co. KG
Am Sägewerk 11
01920 Ralbitz-Rosenthal, Germany
Phone: +49 (0) 35796 / 9760
E-Mail: mail@m-pt.de

4. EU Declaration of Conformity

We M-PT Matjeschk-PowerTools GmbH & Co. KG
Am Sägewerk 11
01920 Ralbitz-Rosenthal

declare in sole responsibility that the product

Machine: Electric Torque Wrench
Series: MED

which refers this declaration, is conform with the following standards or normative documents

- DIN EN IEC 55014-1 VDE 0875-14-1:2022-12
- DIN EN IEC 55014-2 VDE 0875-14-2:2022-10
- DIN EN IEC 61000-3-2 VDE 0838-2:2023-10
- DIN EN 61000-3-3 VDE 0838-3:2023-02
- DIN EN 62841-1 VDE 0740-1:2023-03
- DIN EN 62841-2-2 VDE 0740-2-2 Correction 1:2017-07

in accordance with the guidelines: 2006/42/EG, appendix II A
2014/30/EU
2014/53/EU

Ralbitz-Rosenthal, 12.08.2024

5. Safety Notes

5.1. General Remarks

- Safety of personnel and trouble-free operation can only be warranted with original M-PT components installed. This relates to all elements of the device, accessories and spare parts. M-PT does not assume any responsibility and rejects all corresponding claims in the case of unauthorized installation of foreign parts.

5.2. Surroundings

- The working zone must be clean and sufficiently illuminated.
- The equipment is not appropriate for environment requiring ATEX instrumentation, i.e. the presence of corresponding liquid, gas or dust in proximity of the working zone is strictly forbidden. Sparks could give rise to fire hazard.
- Local legislation and regulations for prevention of accidents must be observed.

5.3. Electrical Safety

- The connector of the tool must match the socket in place. Manipulations are not admissible.
- The tool has not been designed for applications in wet environment (rain, extreme moisture etc.).
- With respect to the cable, generally known rules must be followed (prevention of excessive stress, heat, abrasion or damage caused by sharp edges or moving machine components).
- For outdoor applications, also extension cables -whenever used- must meet the same requirements.
- If operation in humid environment cannot be avoided, a fault current circuit breaker is imperative.

5.4. Safety of Personnel

- Persons not participating in the procedure in question should be kept away, in order not to interfere in the work.
- Tools should be stored protected from unauthorized access.
- The tool should not be left to persons, unconscious of possible danger, or not knowing this manual.
- Protective equipment is required.



5.5. Absence of Damages

- Before starting to work, the entire equipment must be inspected.
- In case of any damages, first repair must be performed – by qualified specialists and by means of original spare parts.
- This is particularly valid in the case of defective switches.
- At the end of the work or before exchanging components, the device must be disconnected from mains.

6. Content

- Electric torque driver, ready-to-use
- Reaction arm
- Locking ring for reaction arm
- User manual with EU declaration of conformity
- Test certificate

7. Product Identification

The type plate with tool designation and serial number is illustrated below.



8. Specification

See type plate and test certificate.

9. Detailed Description

9.1. Start-up

- The instrument is delivered ready-to-use.
- Components and accessories to be added should not impair function and safety of the tool.
- Mains voltage and frequency are specified on the type plate.

9.2. Initial Steps

1. First the reaction arm (2) has to be plugged onto the toothed wheel work (1), as illustrated.
2. In order to secure the reaction arm, insert the locking ring (3) into the corresponding groove of the gearing.
3. The socket (4) has to be shifted onto the integrated square drive bolt. Only sockets with standard square opening, acc. to DIN 3121 should be used.
4. Secure the assembly by pin (5).
5. The pin itself has to be secured as well (from falling out), by means of retaining ring (6).
6. The device can be connected to the mains.

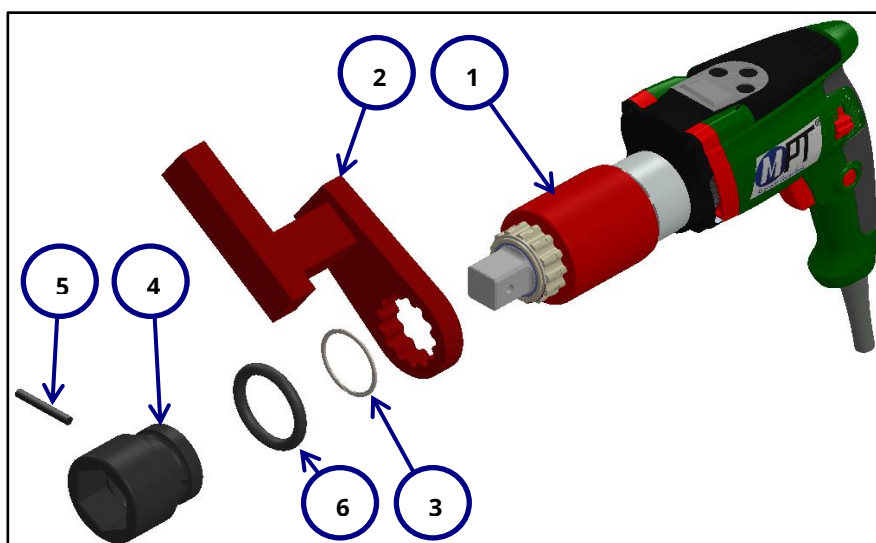

9.3. Switching ON

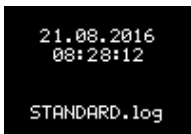

After initialization, the screen displays time and date together with the file currently open. If date and time require adjustment, refer to chapter 9.18. The screen has to be confirmed by pressing key **M**. Note that the screen appears only in the case of bolt documentation system enabled.

9.4. Main Screen

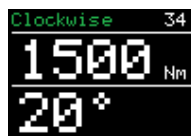

- Upper left: Current sense of rotation
- Upper right: Model ("34" designates the MED 34 series.)
- Center line: Current set value of torque
- Lower line: Set value for angle of rotation
- The last result still remains on the display for 10 sec. after completion of the bolting process.

- In the case of bolting failure, the color of displayed values changes to red. The fault can be acknowledged by any key.

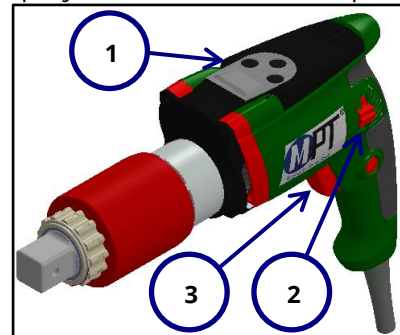

9.5. General Procedure

- Settings have to be entered by keys **M**, **↑** and **↓** (1).
- Sense of rotation is determined by selector switch (2).
- Initiate rotation by start button (3).

9.6. Setting the Torque

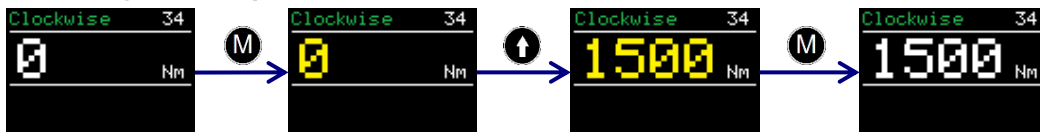

- The last torque in use is shown immediately after switching ON.
- Default value is 0 Nm.
- The sense of rotation is displayed at the upper left corner (as explained above).
- The device type appears at the upper right corner.
- Adjustment of torque is enabled by key **M**.
- The torque value display changes to yellow.
- Increase or decrease the value by keys **↑** and **↓**.
- To speed up adjustment, press and keep pressed the corresponding key (**↑** resp. **↓**).
- To confirm the setting, press **M** one more time.
- The torque value from now on is shown in white.

9.7. Units

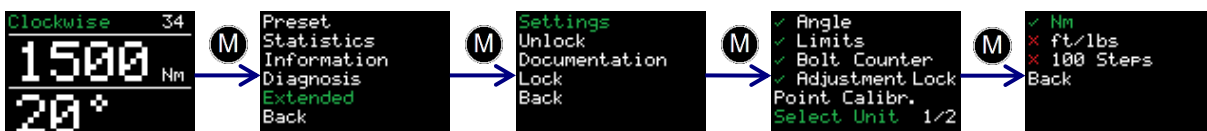

- The torque unit can be chosen in the Settings option of the Advanced Menu and then selecting the unit desired.
- The following possibilities are available:
 - Newtonmeter - Nm
 - Foot-pound - ft/lbs
 - In 100 steps (for fine tuning, consult factory service).
- Recalibration after change of units is not necessary.
- For working in step mode, a torque table is available, consult factory service.

9.8. Adjustment of Follow-up Rotary Angle

- A follow-up rotary angle can only be adjusted, if this feature has been enabled in the Advanced Menu (Extended), as explained in section 9.10.
- Set-up takes place in the main screen, as illustrated below:

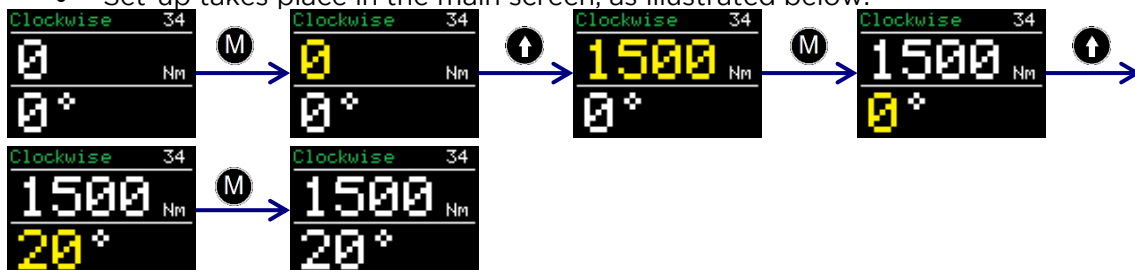

- First the torque itself is adjusted after pressing key **M**. This procedure has already been explained in section 9.6.
- After confirmation of the torque value (by key **M**), adjust the angle by keys **↑** and **↓**.
- Press **M** one more time to confirm the angle setting.
- Note that the angle can only be adjusted within the range between 10° and 360°.
- As soon as the torque exceeds the maximum torque of the tool, the unit automatically switches OFF (refert to specification, section 8).

9.9. Preselections



- Up to 10 preselections defined by the user can be stored.
- For standardized HV connections, preselections are stored as well, but cannot be modified. (HV relates to high-strength prestressed bolts).
- Press **M** for a longer time, to open main menu.
- Press **M** again, to gain access to the menu of preselections (*Preset*).
- Choose between user defined Customerpreset and default HV preselections.
- The following parameters are shown:
 - Order number of preselection
 - Name
 - Torque (see point 9.6)
 - Follow-up Rotary Angle (point 9.8)
 - Limits for final torque (point 9.11)
 - Bolt Counter (point 0)
 - Program type selected (Normal or prove program, refer to point 9.16)
- Call up the preselection desired by means of **↑** and **↓**.
- Pressing key **M** opens a menu with the following options:



- „Accept“: The displayed preselection is accepted as the current setting for the bolting process.



- „Overwrite“: Data of the displayed preselection are modified, i.e. overwritten by the current settings.



- „Cancel“: Return to displayed preselection.



- „Back “: Return to Preselection menu.

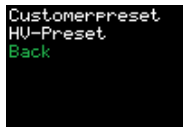

- Press „Back“ again to return to the main screen.

- HV preselections however are fixed and cannot be modified. They are displayed in conformity with the torque range available for the model concerned.
- Default tightening torques for HV bolts relate to the modified torque method acc. to DIN EN 1993-1-8 for k-class K1.

9.10. Advanced Menu

- Access to Advanced Menu (*Extendet*) requires password entry. The default code is „17580“.
- If this code is intended to be modified, open “Password”, accessible in the main menu.

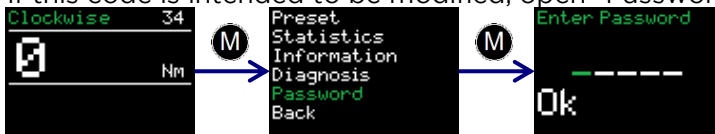

- In the Advanced Menu, the following options are provided:
 - Advanced functions:
 - Activation of follow-up rotary angle (refer to point 9.8)
 - Activation of limits (point 9.11)
 - Activation of Bolt Counter (point 9.12)
 - Point calibration (point 9.14)
 - Selection of units (point 9.7)
 - Language (point 9.15)
 - System Release (consult factory service)
 - Bolt Documentation System (point 9.17)
 - Lock Advanced Menu

9.11. Limits

- Before specifying limits themselves, activate this function in the Advanced Menu:

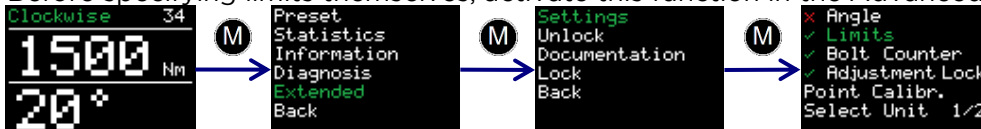

- Limits can be defined to each final tightening torque.
- For pure torque tightening, limits can be assigned to angles. This angle is counted up from minimum torque of the device.
- For torque-rotary angle tightening however, limits apply to the final torque.
- These limits can be entered in the main screen, after completion of setting for torque and follow-up angle:

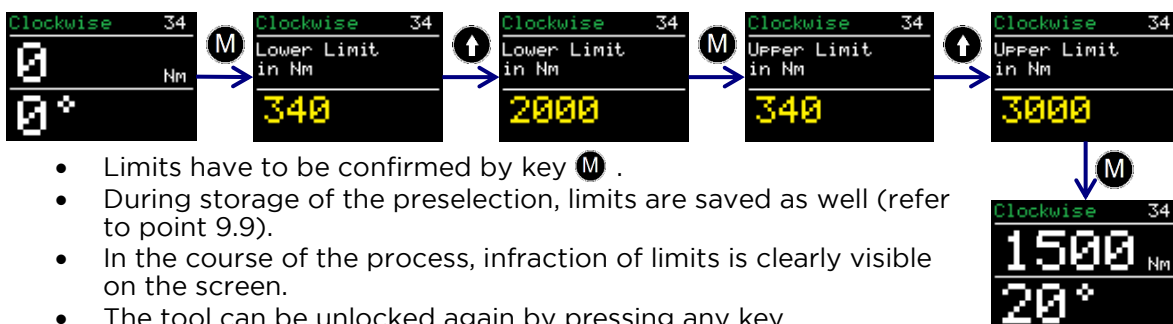

- Limits have to be confirmed by key **M**.
- During storage of the preselection, limits are saved as well (refer to point 9.9).
- In the course of the process, infraction of limits is clearly visible on the screen.
- The tool can be unlocked again by pressing any key.



9.12. Bolt Counter

- The bolt counter is enabled or disabled in the Advances Menu as well.

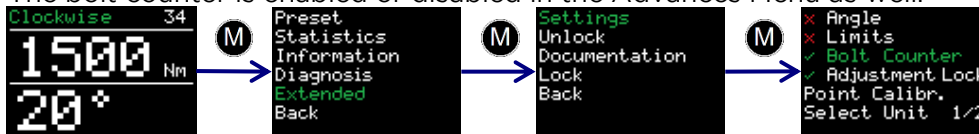

- Setting takes place again in the main screen:



- Once enabled, set the counter to any value between 1 and 999.
- The counter reacts to all successful bolting procedures carried out in right-handed rotation.
- After arrival at the selected number, the tool automatically is locked. To restart operation, proceed as follows:
 - Choose a new number or
 - Disable the counter
- If during an activated run the tool is disconnected from the mains, it restarts from the current position after switching ON (i.e. the progress is stored in non-volatile memory).
- To avoid double counting of bolts tightened already beforehand (by erroneously selecting a corresponding bolt a second time), it is recommended to use the counter together with the limit function (point 9.11), and e.g. to set for torque tightening the lower test angle to 10°.

9.13. Adjustment Lock

- The adjustment lock is enabled or disabled in the Adavaced Menu as well.

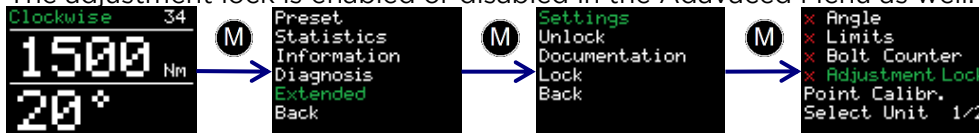

- If the adjustment lock is activated, the torque can not be changed.
- Only the saved presets (point 9.9) can be selected.

9.14. Point Calibration

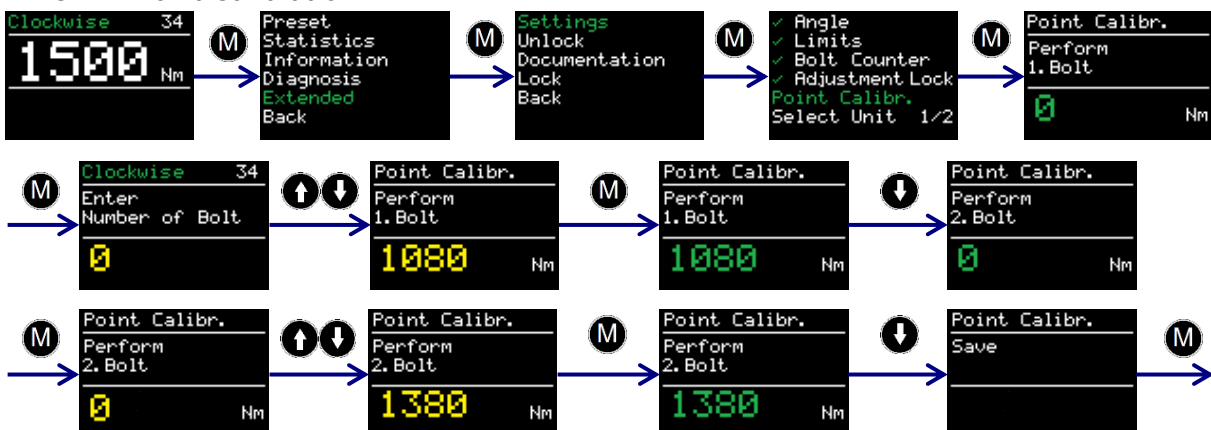

- The precision of the tool for particular bolt cases can be increased by point calibration.
- For reference measurement of the real torque, a measuring device (e.g. the Smart Socket™ described in section 16.6) is necessary.
- The torque desired is set up in the main screen.
- The point calibration can be stored in form of a preselection (section 9.9).

- Activate the calibration procedure in Advanced Menu, option „Point Calibr.“
- The screen shows „Perform 1. Bolt“
- The first bolting has to be carried out.
- Enter the result in the display.
- To select the second bolting procedure, press **↓** .
- Perform the second procedure, and enter the result again.
- Complete the calibration by pressing **↓** and then **M** .

9.15. Languages

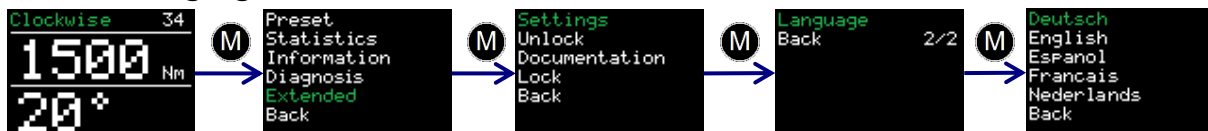

- In the Advanced Menu, choose between the following five languages:
 - German
 - English
 - Spanish
 - French
 - Dutch
- After confirmation of the language, the device automatically performs restart.

9.16. Prove Program

- The Prove Program is not included in the standard delivery, it is available upon request. It has been developed for verification of tightened bolt connections.
- This feature can be enabled by option “Prog. selection”, as shown below:



- After Prove Program enabled, the display shows in an alternating sequence the word „Prove“ and the torque selected.
- The Prove Program establishes the selected torque in a slow rise.
- If the real torque of the bolt is lower than the test torque, the tool further tightens the bolt until the desired value is reached.
- After completion, the follow-up angle appears on the screen.
- If in the Advanced Menu, limits have been activated (point 9.11), the tool performs an assessment of the follow-up angle.
- In the case of follow-up angle outside tolerance, the value is shown in red, the limit concerned is mentioned as well „Upp. Lim.“ resp. „Low. Lim.“.
- Acknowledge the fault by pressing any key.
- Otherwise the value is shown in green.
- Note that the speed of the tool in test mode is lowered (compared to normal operation).
- Even for tight bolt connection, the elastic deformation of the reaction arm gives rise to a displayed follow-up angle of ca. 1 to 3°. The exact value has to be determined before starting the test routine, and to be taken into account for evaluation.

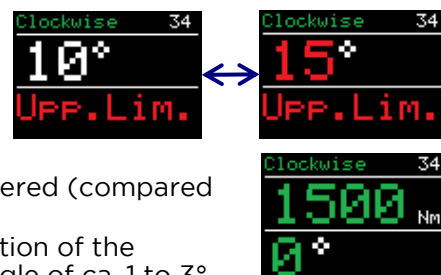

9.17. Bolt Documentation System

- The Bolt Documentation System as well is not part of the standard delivery content.
- After purchasing and installation of the software, the Advanced Menu features the submenu „Documentation“
- Quick access is also possible by pressing both arrow keys simultaneously.

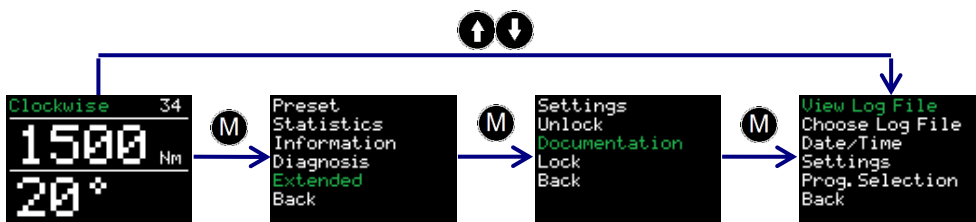

- The following commands are contained in the documentation menu:
 - View Log File: Inspect data of all boltings completed.
 - Choose Log File: A new file can be created.
 - Date/Time: The current time and date can be set, acc. to instructions in section 9.18.
 - Settings: Entry of a user identification (see also point 9.19), and data transfer to PC can be activated/disabled.
 - Program used: The decision between normal and prove program is made in this sub-menu (section 9.16).
- The following data are saved within the files:
 - Current number: A number is assigned to each bolting disposing of a torque above the minimum tool torque.
 - Process number: Assigned to each bolt successfully tightened in right-handed rotation.
 - Date and time
 - Set and real torque
 - Selected torque unit
 - Set and real rotating angle
 - Final torque for rotating angle tightening
 - Limits selected (see point 9.11)
 - Total angle and bolting time
 - Mains voltage and frequency
 - Program type (normal or prove program)
 - User (see section 9.19)
- A new file can be created by "Choose Log File".
- Store this file ("Save") to activate it.
- Pressing key **M** for a longer time erases the entry.
- When storing an empty entry, the last file automatically continues to be used further.

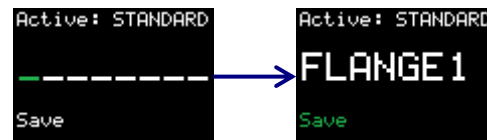
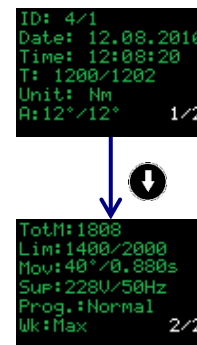

9.18. Set Date and Time

- Date and time within the system are displayed and used only with documentation feature enabled.
- Before setting date and time, enter password to open the Advanced Menu (point 9.10).

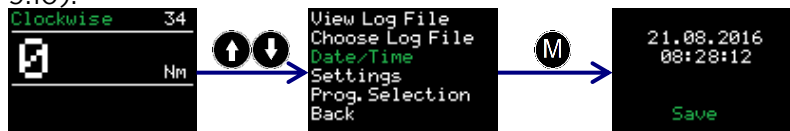

- The clock can be synchronized by software included in the delivery (point 11).

9.19. Identification of a Operator

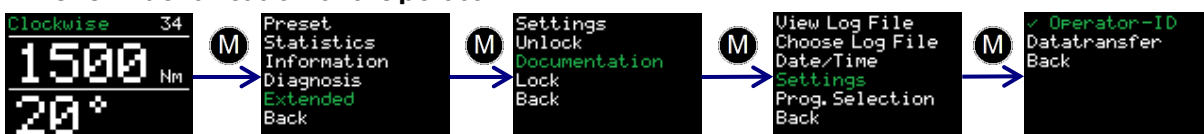

- Activation/disabling of user ID takes place under 'Settings' in the documentation menu.
- Once enabled, the system during start-up requests for entry of an ID (eight characters), to be included in the documentation as well.

9.20. Total and Maintenance Counter

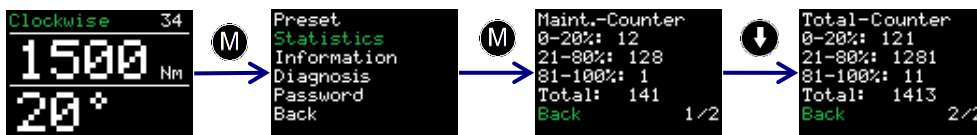

- Total and Maintenance Counter are located in the Statistics Menu.
- The first value relates to the entity of bolting procedures performed by the present tool, the latter number to the procedures carried out after the last maintenance.
- Both counters are subdivided into:
 - 0 - 20 % of maximum torque
 - 21 - 80 %
 - 81 - 100 %
 - 0 - 100 % of maximum torque (this is the total value)
- When 20,000 boltings are reached, the message „Schedule the Maintenance“ informs the user, that the next maintenance routine is required.

9.21. Device Information

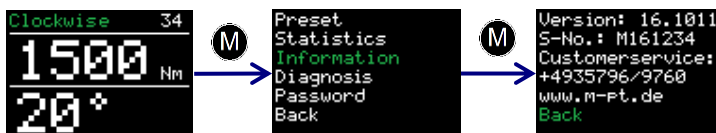

- The following information is available here:
 - Version no. of software
 - Serial no. of tool
 - Phone number of factory service and website of manufacturer

9.22. Diagnosis

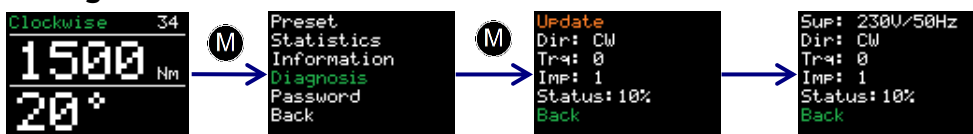

- The option „Diagnosis“ is not intended for the user himself, but is required sometimes for consultation of factory service by phone.

9.23. Key Lock

- Simultaneous pressing of **M** and **↑** keys for 3 sec. activates key lock.
- Repeat the same procedure to unlock the keys again.
- With key lock enabled, the display cannot be modified. The tool itself however goes on working as usual.

10. Support for Reaction Arm

Height of Reaction Arm:

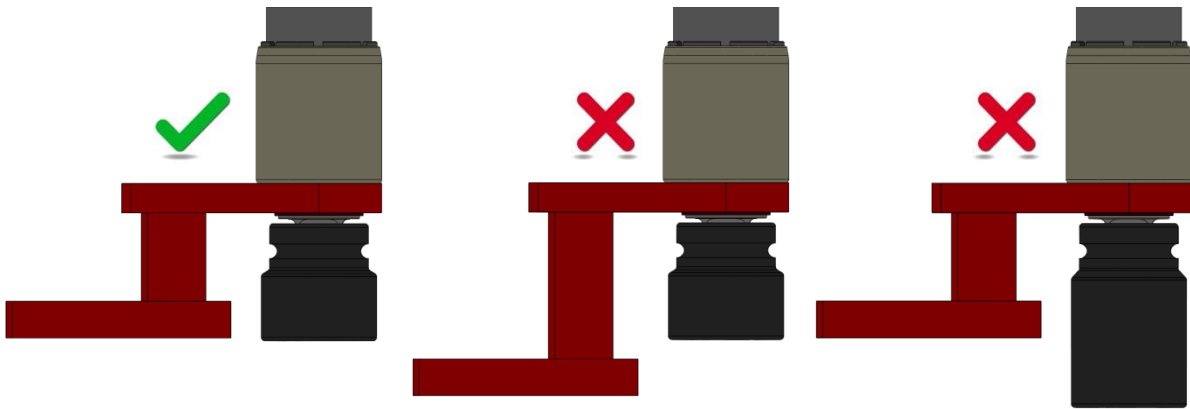

Support for Reaction Arm:

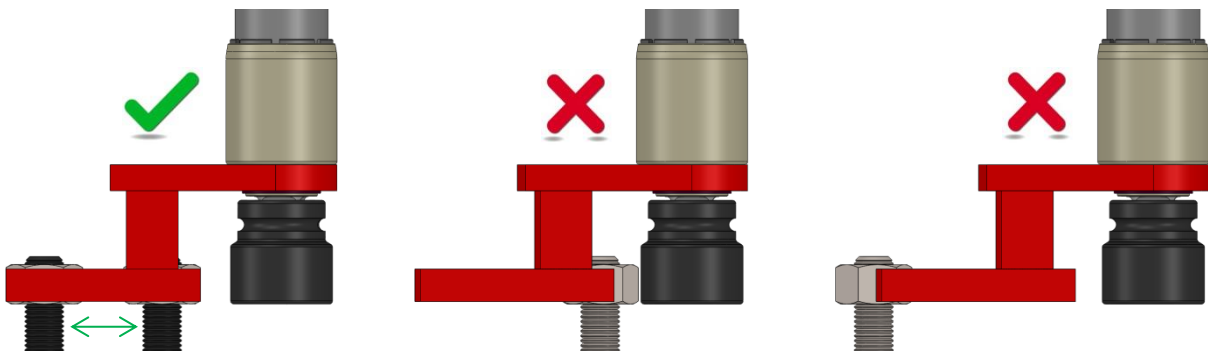

Danger of Squeezing:

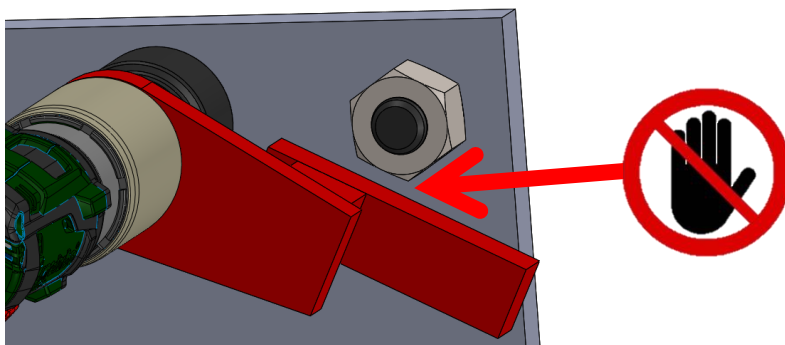

11. PC-Software MED-Datalogger

11.1. Add the electric torque driver as Bluetooth-Device under Windows

1. Install the Bluetooth-Stick included in the delivery.
2. Activate data connection at the tool itself. The feature "Data transfer" is available in the Settings submenu of the Documentation menu described beforehand.
3. In the Start menu of the PC, select function „Devices and Printers“.
4. Command „Add Device“.
5. Select the serial number of the tool (e.g. MED-M123456).
6. Command „Next“.
7. After successful implementation, click on „Close“.
8. In window „Devices and Printers“, mark the serial number of the tool by a right click.
9. Select „Properties“ menu.
10. Select „Hardware“ tab.
11. The relevant COM port (e.g. „COM11“) can be found in the name designation of the Bluetooth connection.
12. Close all windows.

11.2. Software Installation in Windows

13. The installation routine is initiated by start of „setup.exe“.
14. Licence conditions have to be confirmed.
15. Command „Next“
16. Select the folder desired for storage, click on „Next“.
17. Click on „Next“.
18. After completion, click on „Close“.
19. The data connection at the device is finished by „Back“.

11.3. Software Set-up

1. Open „MED-Datalogger“ software by a link on the desktop.
2. Under „Select Port“, designate the COM port determined in section 11.1 (e.g. „COM11“).

11.4. Read-out of Data

- Activate data connection at the tool itself. The feature "Data transfer" is available in the Settings submenu of the Documentation menu described beforehand.
- Click on „Load data“.
- During first selection of the tool, a particular designation must be assigned e.g. an inventory number or a distinct name.
- Confirm by command „Save“.
- While loading a new file, a particular designation must be assigned, e.g. plant or order number.
- Confirm by command „Save“.
- Progress of the loading process is visualized at the left lower corner of the screen. The speed amounts to ca. 3 records/sec.
- After completion, tool and file can be selected at the upper left corner of the screen.
- Together with the name of tool and file, a table with recorded data is displayed.

11.5. Saving and Print of Data

- To create a printout, select the Print option in the tab ‚Menu‘.
- When storing a file in form of a .pdf, first in the print menu a pdf-printer has to be selected (the installation CD contains a corresponding element).
- To store in form of .csv or .xlsx files, select the Export option in the tab ‚Menu‘, and then the suffix desired.

11.6. Synchronization of the Clock

- Activate data connection at the tool itself. The feature "Data transfer" is available in the Settings submenu of the Documentation menu described beforehand.
- In the tab ‚Menu‘, select option ‚Synchronize Clock‘.

12. Trouble-Shooting

If a particular problem cannot be solved on the basis of the instructions listed below, consult factory service immediately. Improvised repair is not recommended.

12.1. Message "Voltage Fault"

The mains voltage is obviously out of tolerance (nominal value 3 25V), refer to point 8.

12.2. Message "Sensor Fault"

Impulse transmitter is defective.

12.3. Message "Insert SD Card"

The SD card has not been recognized.

12.4. Instead of letters, the display shows merely lines

The SD card has not been recognized.

12.5. Incorrect Date and Time

The battery is empty (if the problem is not due to transport to another time zone).

12.6. Adjustment of Minimum or Maximum Torque Impossible

Possible reasons:

- Incorrect calibration
- Internal memory corrupted, consult factory service

12.7. No Reaction to Key Commands

If the problem cannot be solved by restart, the membrane keyboard is defective.

12.8. No Reaction to Start Button

Possible reasons:

- Torque set to 0 Nm.
- Bolt Counter activated and set to 0.
- Bolt Counter activated, preselected number reached, all boltings complete.
- Button itself defective.

12.9. In left-handed rotation, bolts are not detached

Possible reasons:

- Torque required exceeds maximum torque of the tool.
- Selector switch Left/Right is defective.

12.10. Error Message after Completion of Bolting

Possible reasons:

- Limits have been enabled, but not correctly adjusted.
- Bolt excessively tightened (e.g. a connection already fixed is tightened once more).
- The tool during rotary angle bolting has reached its maximum torque. In corresponding cases, the instrument automatically is switched OFF to protect internal components. Simultaneously an error message appears.
- The start button has been released before the tool is disabled.

13. Accessories

13.1. Tool Suspension

In order to simplify work and avoid unprofessional constructions, stable suspensions, to be attached to the gearings, are available for all tool models. Consult factory service.

13.2. Extension Pieces

Extension pieces in different lengths are available for all models, to grant access also to recessed positions or in narrow places.

13.3. Sockets and Securing Pins

Sockets and reaction arms must mutually match. To obtain a convenient configuration, consult factory service.



14. Disclaimer

This manual has carefully been prepared. In the case of supplementary questions, do not hesitate and consult factory service. The manufacturer does not assume any responsibility for technical or typographic mistakes; technical specifications and corresponding instructions are subject to change without notice. The manufacturer is not responsible for direct or indirect consequential damages in connection with equipment, services or use of the product. No warranty is given for the content of this document.

The warranty exclusively relates to defects in material and workmanship and becomes null and void in the case of misuse, abuse, neglect and improper use. It is strictly forbidden to manipulate components or to perform repair by means of parts not approved by the manufacturer in writing. Improper use or misapplications shall be construed to include excess of any specification of the equipment.

15. Maintenance / Service

15.1. General Remarks

- Safety and correct function of the tool can only be ensured by regular maintenance.
- Procedures like mounting, new adjustment, modifications, functional upgrading and repair are reserved to M-PT factory service, if no other authorization is given in writing.
- Installation of original M-PT spare parts is mandatory, foreign parts are not admissible. This includes all internal components and accessories.

15.2. Visual Inspection

Visual inspection is required in regular intervals and refers to following criteria:

- Absence of external damage
- Function of movable parts
- Damages of shaft, drive and reaction arm

15.3. Service Intervals

- The convenient service interval depends on frequency of use.
- For permanent bolting at an intensity of up to 80% of maximum torque, maintenance after 20,000 procedures is recommended.
- An individual maintenance conception matching the requirements of the application can be discussed with our factory service.

15.4. Spare Equipment

- If during repair or maintenance, a spare tool is required, rental equipment is available any time.

15.5. Calibration

- The period of validity of the factory calibration amounts to 1 year, frequency of use is not taken into consideration.

15.6. Manufacturer's Address



M-PT Matjeschk-PowerTools GmbH & Co. KG
Am Sägewerk 11
01920 Ralbitz-Rosenthal, Germany
Telefon: +49 (0) 35796 / 9760
E-Mail: mail@m-pt.de

16. Product Overview

16.1. Battery Torque Wrench

- Torque range 30-15.000 Nm
- Repeatability from $\pm 2,8$ %
- Torque/angle controlled tightening
- Data Logging
- Torque Check Function for maintenance
- Limit value monitoring



16.2. Electric Torque Wrench

- Torque range 65-16.500 Nm
- Repeatability from $\pm 2,8$ %
- Torque/angle controlled tightening
- Data Logging
- Torque Check Function for maintenance
- Limit value monitoring



16.3. Pneumatic Torque Wrench

- Torque range 35-15.000 Nm
- Repeatability of $\pm 5,0$ %
- Available with ATEX certification

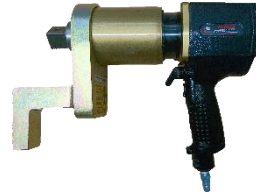

16.4. Hydraulic Torque Wrench

- Torque range 110-101.600 Nm
- Repeatability of $\pm 3,0$ %
- Square drive and cassette type
- 360° x 180° multi-positional swivel couplings



16.5. Hydraulic High Performance Pumps

- Pressure range 700-2.000 bar
- For hydraulic torque wrenches and bolt tensioners
- Data Logging



16.6. Software for Bolting Systems

- Documentation System for data logging
- Torque Check Function for bolt maintenance
- ProTight™ worker guidance system
- BoltPilot® data monitoring

16.7. Transducer Smart Socket™

- Accuracy of transducer $\pm 1,0$ %
- Graphical display of torque curve
- Data logging software



16.8. Rental

- All tools are also available in our rental park.